

Eclipse Vortometric

Burners

Models HI and MI

Version 4

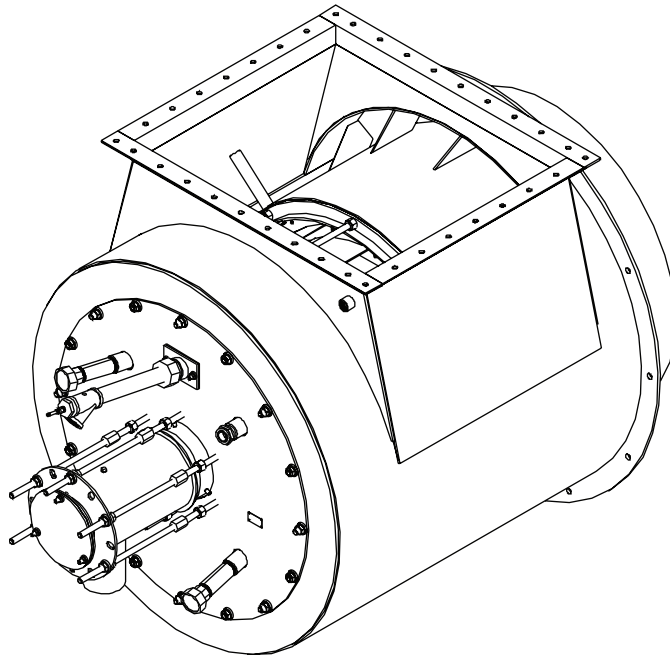

Copyright

Copyright 2007 by Eclipse, inc. All rights reserved worldwide. This publication is protected by federal regulation and shall not be copied, distributed, transmitted, transcribed or translated into any human or computer language, in any form or by any means, to any third parties, without the express written consent of Eclipse, inc.

Disclaimer Notice

In accordance with the manufacturer's policy of continual product improvement, the product presented in this brochure is subject to change without notice or obligation.

The material in this manual is believed adequate for the intended use of the product. If the product is used for purposes other than those specified herein, confirmation of validity and suitability must be obtained. Eclipse warrants that the product itself does not infringe upon any United States patents. No further warranty is expressed or implied.

Liability & Warranty

We have made every effort to make this manual as accurate and complete as possible. Should you find errors or omissions, please bring them to our attention so that we may correct them. In this way we hope to improve our product documentation for the benefit of our customers. Please send your corrections and comments to our Technical Documentation Specialist.

It must be understood that Eclipse's liability for its product, whether due to breach of warranty, negligence, strict liability, or otherwise is limited to the furnishing of replacement parts and Eclipse will not be liable for any other injury, loss, damage or expenses, whether direct or consequential, including but not limited to loss of use,

income, or damage to material arising in connection with the sale, installation, use of, inability to use, or the repair or replacement of Eclipse's products.

Any operation expressly prohibited in this manual, any adjustment, or assembly procedures not recommended or authorized in these instructions shall void the warranty.

Document Conventions

There are several special symbols in this document. You must know their meaning and importance.

The explanation of these symbols follows below. Please read it thoroughly.

How To Get Help

If you need help, contact your local Eclipse representative. You can also contact Eclipse at:

1665 Elmwood Rd.
Rockford, Illinois 61103 U.S.A.
Phone: 815-877-3031
Fax: 815-877-3336
<http://www.eclipsenet.com>

Please have the information on the product label available when contacting the factory so we may better serve you.

 ECLIPSE <small>Innovative Thermal Solutions</small>	www.eclipsenet.com
Product Name	
Item #	
S/N	
DD MMM YYYY	



This is the safety alert symbol. It is used to alert you to potential personal injunt hazards. Obey all safety messages that follow this symbol to avoid possible injury or death.



Indicates a hazardous situation which, if not avoided, will result in death or serious injury.



Indicates a hazardous situation which, if not avoided, could result in death or serious injury.



Indicates a hazardous situation which, if not avoided, could result in minor or moderate injury.

NOTICE

Is used to address practices not related to personal injury.

NOTE

Indicates an important part of text. Read thoroughly.



Table of Contents

Introduction	4
Product Description	4
Audience.....	4
Vortometric Documents	4
Purpose	4
Safety	5
Introduction	5
Safety	5
Capabilities	5
Operator Training	5
Replacement Parts	5
System Design	6
Design	6
Step 1: Burner Model Selection	6
Step 2: Design Considerations	7
Step 3: Control Methodology	9
Step 4: Ignition System.....	13
Step 5: Flame Monitoring System	13
Step 6: Combustion Air System: Blower.....	14
Step 7: Main Gas Shut-Off Valve Train	15
Step 8: Process Temperature Control System	16
Appendix	16
Conversion Factors	16
Key to System Schematics.....	17

Introduction

1

Product Description

Eclipse Vortometric Burners are built to fire a variety of fuels at very high inputs. They operate over a wide range of excess air levels on a variety of fuels including natural gas, propane, butane, fuel oil and alternative fuels. The Vortometric burners feature a high combustion air swirl that provides a stable flame with high turndown capabilities and low NO_x and CO emissions.

Vortometric burners are available in the MI (Medium Intensity) and HI (High Intensity) series. The MI series provides a smaller diameter, longer flame than the HI series and comes with either a refractory, air cooled alloy or single alloy tube (non air-cooled combustor). The HI series burners have a larger diameter shorter flame and are only available with the refractory lined combustor.

Both the HI and MI series Vortometric burners are available in 12 sizes which operate over a range of 6,000,000 to 210,000,000 BTU/h (1,760 to 61,500 kW) making them ideal for large dryers, ovens, kilns, thermal fluid heaters, thermal oxidizers, oil heaters, vaporizers, boilers, liquid and waste incineration and other air heating applications.

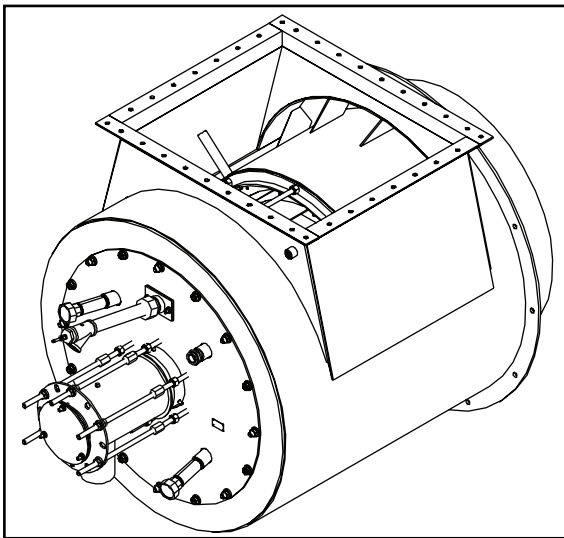

Audience

This manual has been written for people who are already familiar with all aspects of a nozzle-mix burner and its add-on components, also referred to as “the burner system”.

These aspects are:

- Design / Selection
- Use
- Maintenance

The audience is expected to have previous experience with this type of equipment.

Vortometric Documents

Design Guide No. 128

- This document

Datasheet, Series No. 128-1 through 128-3

- Available for individual Vortometric models
- Required to complete design calculations in this guide

Installation Guide No. 128

- Used with Datasheet to complete installation

Worksheet No. 128

- Required to provide application information to Eclipse Engineering

Related Documents

- EFE 825 (Combustion Engineering Guide)
- Eclipse Bulletins and Info Guides: 610, 710, 720, 730, 742, 744, 760, 930, 940, 908

Purpose

The purpose of this manual is to ensure that the design of a safe, effective, and trouble-free combustion system is carried out.

Safety

Important notices which help provide safe burner operation will be found in this section. To avoid personal injury and damage to the property or facility, the following warnings must be observed. All involved personnel should read this entire manual carefully before attempting to start the system. If any part of the information in this manual is not understood, contact Eclipse before continuing.

Safety Warnings

DANGER

- The burners, described herein, are designed to mix fuel with air and burn the resulting mixture. All fuel burning devices are capable of producing fires and explosions if improperly applied, installed, adjusted, controlled or maintained.
- Do not bypass any safety feature; fire or explosion could result.
- Never try to light a burner if it shows signs of damage or malfunction.

WARNING

- The burner and duct sections are likely to have HOT surfaces. Always wear the appropriate personal protective equipment when approaching the burner.

NOTICE

- This manual provides information regarding the use of these burners for their specific design purpose. Do not deviate from any instructions or application limits described herein without written approval from Eclipse.

Capabilities

Only qualified personnel, with sufficient mechanical aptitude and experience with combustion equipment, should adjust, maintain or troubleshoot any mechanical or electrical part of this system.

Operator Training

The best safety precaution is an alert and trained operator. Train new operators thoroughly and have them demonstrate an adequate understanding of the equipment and its operation. A regular retraining schedule should be administered to ensure operators maintain a high degree of proficiency.

Replacement Parts

Order replacement parts from Eclipse only. All Eclipse approved valves or switches should carry UL, FM, CSA, CGA and/or CE approval where applicable.

System Design

3

Design

When selecting a Vortometric burner, choices are available to define a burner that will be safe and reliable for the system in which it will be installed. The design process is divided into the following steps.

1. Burner Model Selection:

- a. Burner Size and Quantity
- b. Burner Type
- c. Flame Rotation
- d. Fuel Selection
- e. Combustor Type
- f. Gas Inlet Orientation
- g. Gas Pilot Orientation
- h. Pipe Connection

2. Design Considerations:

- a. Air Inlet Design
- b. Firing Vertically Down
- c. Oil Firing System
- d. Flame Shielding
- e. Combustion Chamber Pressure Tap
- f. Chamber Size
- g. Process Air Velocity
- h. Combustion Air Inlet Pressure Tap
- i. Burner Gas Pilot

3. Control Methodology

4. Ignition System

5. Flame Monitoring System

6. Combustion Air System

7. Main Gas Shut-Off Valve Train Selection

8. Process Temperature Control System

Step 1: Burner Model Selection

Burner Size and Quantity

Select the size and number of burners based on the heat required. For heat requirement calculations refer to the Combustion Engineering Guide (EFE 825).

Performance data, dimensions, and specifications are given for each Vortometric model in Datasheets 128-1 through 128-3.

Burner Type

Select the burner type, either HI (High Intensity) or MI (Medium Intensity). The HI Vortometric has a larger diameter combustor than the MI and provides a shorter flame which concentrates more heat within the tube. The HI is available only with a refractory style combustor and can be supplied with an oil lance to burn liquid fuels in addition to natural gas, propane and butane.

The MI is capable of burning natural gas, propane and butane. It has a smaller diameter combustor which produces a longer flame than the HI. The smaller diameter combustion tube does not get as hot as that of the HI. The longer flame spreads the heat over a wide area, away from the combustor, allowing the use of alloy tube combustors. Refer to the datasheets to verify the flame geometry is compatible with the application.

Flame Rotation

The Vortometric contains a volute section that swirls the air in either a clockwise (CW) or counter clockwise (CCW) rotation. This flexibility can help optimize the performance of the system depending on how combustion air directionally enters the system and how exhaust gases are passed downstream.

Eclipse recommends that minimum piping runs be followed when designing the combustion air ducting upstream of the burner to ensure smooth air flow. In systems where the combustion air blower is mounted close to the burner inlet it is advisable to select the flame rotation that best agrees with the exit profile of the combustion air from the blower. This ensures that the highest velocity flow from the blower does not oppose the burner flame rotation. See notes in the "Air Inlet Design" section on page 7 for suggestions to straighten flow into the air inlet.

Clockwise is considered the standard design, observing through the peep site at the cold end of the burner.

Fuel Selection

The Vortometric burners are capable of burning multiple fuels depending on which model is used. The Vortometric MI can be used for burning natural gas, propane and butane. The Vortometric HI can be used for natural gas, propane, butane, and, with the addition of an atomizing oil lance, it can burn light and heavy fuel oils.

In addition, both the MI and HI Vortometric burners are capable of burning alternative fuels such as bio-gas, hydrogen, alcohol, char slurry and corn syrup. Heating of liquid fuels may be required for complete combustion. Consult Eclipse when considering the use of alternative fuels.

Fuel Type

Fuel	Symbol	Gross Heating Value	Specific Gravity	WOBBE Index
Natural Gas	CH ₄ 90%+	1000 BTU/ft ³ (40.1 MJ/m ³)	0.60	1290 BTU/ft ³
Propane	C ₃ H ₈	2525 BTU/ft ³ (101.2 MJ/m ³)	1.55	2028 BTU/ft ³

BTU/ft³ @ standard conditions (MJ/m³ @ normal conditions)

If using an alternative fuel supply, contact Eclipse with an accurate breakdown of the fuel components

Combustor Type

Due to its high maximum allowable operating temperatures (up to 2200°F), the combustor for the Vortometric HI is only supplied with a refractory lining. The lower operating temperatures of the MI allow three different types of combustors: refractory lined (2200°F), air cooled alloy (1600°F) and single alloy tube (1200°F).

If normal operation of the system requires that the burner input is reduced to low fire or the burner has been cut off completely and the firing chamber is hot (over 1000°F or 540°C), it is necessary that low fire combustion air flow is supplied to the burner to avoid overheating and possible damage to the combustor.

Gas Inlet Orientation

The Vortometric burners can be provided with the gas lance inlet located in either the 0, 90, 180 or 270° positions to allow for system design flexibility, see Figure 3.1.

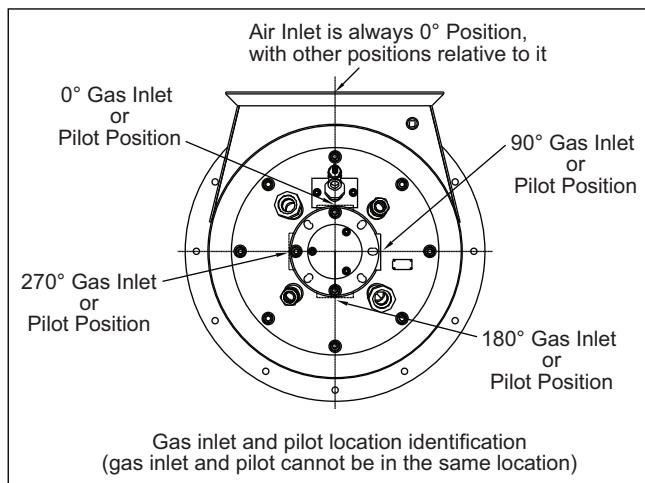

Figure 3.1 - Gas Lance & Gas Pilot (Optional Positions)

Gas Pilot Orientation

The pilot for the Vortometric can be positioned in any of the 3 quadrants not occupied by the gas lance inlet, to allow the best access to the pilot inlet, see Figure 3.1.

Pipe Connection

The Vortometric can be supplied with NPT or BSP pipe fittings. For sizes 16V and above the gas inlet has an ANSI or DIN flange.

Step 2: Design Considerations

In addition to the previous steps to configure a Vortometric burner, the following items may need to be considered in applying the Vortometric into a system:

Air Inlet Design

It is important to have good flow distribution for combustion air coming into the burner. The velocity across the inlet should not vary by more than +/- 20%. A straight duct section leading up to the inlet is preferred. Flow-straightening vanes may be necessary with other configurations. Multi-blade dampers with opposing vanes supported by bearings are preferred to aid even flow distribution.

Firing Vertically Down

When firing vertically down the selection of the combustor must be considered. If a refractory is to be used, it must be acceptable that even under normal conditions some cracking and chipping may occur, allowing refractory fragments to enter the underlying chamber. Using an alloy tube will not present additional problems (same limitations as horizontal firing).

Provisions must be made to stop the hot exhaust gases from passing back through the burner if there is a power failure.

Oil Firing System

There is concern that during post purge unburnt oil will be released into the system. Installation of refractory is the customer's responsibility with no guarantee on the refractory life from Eclipse.

Flame Shielding

Incoming process air should not flow directionally across the face of the burner, because that would affect flame stability and emissions. When this is a concern, flame shields may be added. The diameter of the shield should be the same as the recommended chamber diameter (Figure 3.3). To improve flame stability the shield should be at least 2/3 the length of the flame, which is given in the burner datasheets.

When using #6 fuel oil it is necessary to line the inside of the flame shield with refractory to protect the stainless steel liner.

If there is concern that the process flow will quench the flame and produce CO, then the flame shield should be at least 80% of the flame length. When it is necessary to introduce a controlled amount of dilution air into the flame

(for example, to maintain an acceptable temperature inside the shield) the shield should have a gap at the front wall as shown in Figure 3.2. Note that this could produce undesirable combustion.

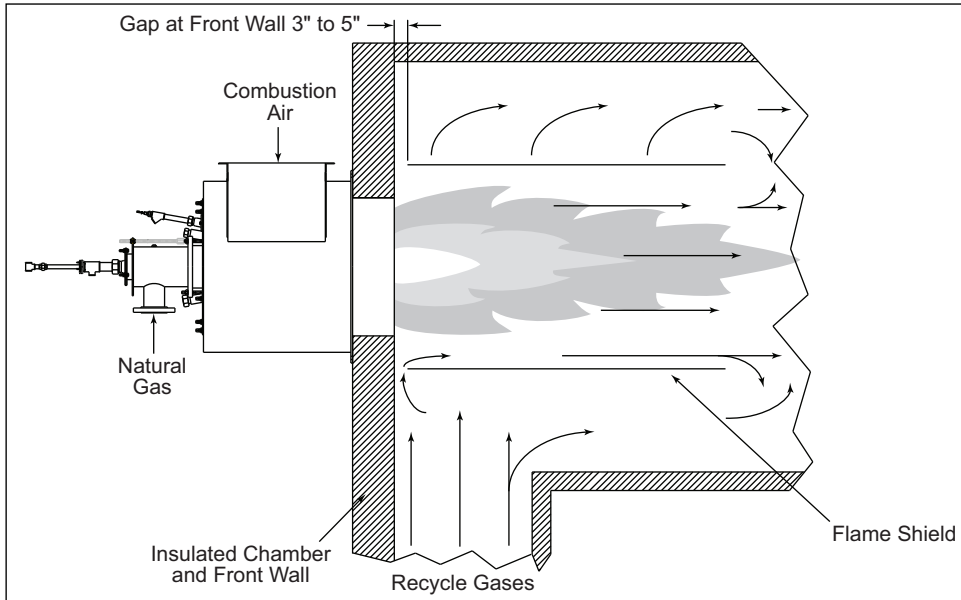

Figure 3.2 - Flame Shield (Typical Example with Gap)

Table 3.1 - Minimum Chamber Dimensions

Burner Model	Capacity MM BTU/h (MW)	Minimum Chamber Dimensions MI		Minimum Chamber Dimensions HI	
		Internal Diameter Inches (mm)	Length Inches (mm)	Internal Diameter Inches (mm)	Length Inches (mm)
VM06	6 (1.7)	32 (813)	72 (1828)	36 (914)	60 (1524)
VM08	10.5 (3.0)	32 (813)	84 (2134)	42 (1067)	72 (1830)
VM10	17 (4.9)	42 (1079)	107 (2718)	47 (1194)	94 (2388)
VM12	23 (6.7)	49 (1255)	124 (3150)	54 (1375)	109 (2769)
VM14	32 (9.3)	58 (1480)	146 (3708)	64 (1621)	128 (3251)
VM16	42 (12.3)	67 (1696)	167 (4242)	73 (1857)	147 (3734)
VM18	55 (16.1)	76 (1940)	191 (4851)	84 (2126)	168 (4267)
VM22	78 (22.8)	91 (2311)	228 (5791)	100 (2531)	200 (5080)
VM24	90 (26.3)	98 (2482)	245 (6223)	107 (2719)	215 (5461)
VM28	125 (36.6)	115 (2925)	288 (7315)	126 (3204)	253 (6426)
VM32	160 (46.8)	130 (3309)	326 (8280)	143 (3625)	286 (7264)
VM36	210 (61.5)	149 (3791)	374 (9500)	164 (4153)	328 (8331)

Firing density is used to determine the above dimensions.

Area = Gross Heat Input (BTU/h) / Firing Density; Dia = sqrt(4*Area/PI)

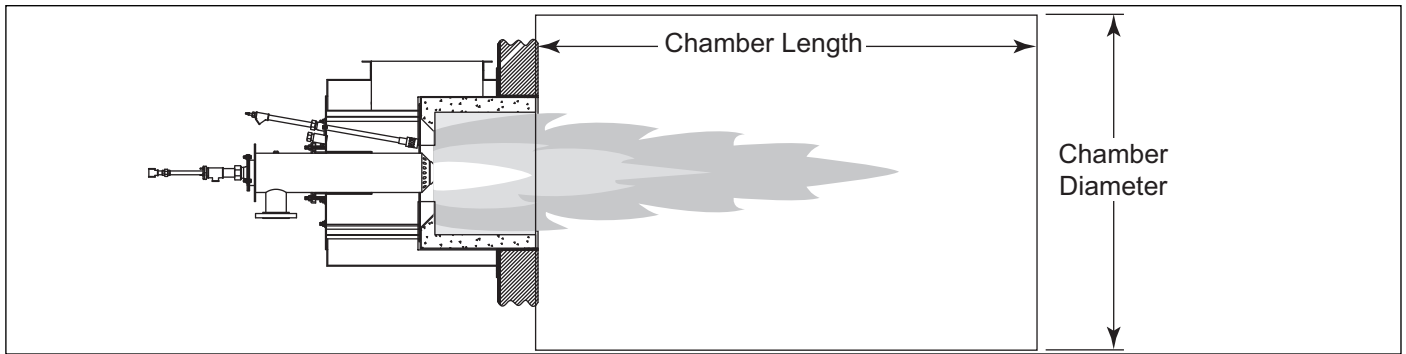

Figure 3.3 - Chamber Size

Combustion Chamber Pressure Tap

When commissioning the burner pressure differentials between input lines and the combustion chamber will need to be measured. It is very important to allow a method of accessing a pressure tap in the combustion chamber when the system is being designed.

Chamber Size

The minimum recommended chamber size for each size burner is shown in Figure 3.3.

NOTE: For flame length and diameter see datasheet series 128-1 through 128-3.

Process Air Velocity

The allowable process air velocity is a function of many factors. Contact Eclipse for more information.

Preheated Air

The maximum preheat combustion air temperature for the Vortometric is 500°F.

For the HI series Vortometric, there is no need to increase the burner size when using preheated air. However, when using preheated air, a higher pressure blower will be needed if the burner is to operate at full capacity.

For the MI series Vortometric, when using preheated air below 250°F, it is not necessary to increase the burner size. A higher pressure blower is not needed to operate at full capacity.

For the MI series Vortometric, operating from 250 to 500°F, the next size of burner is needed to operate at full capacity. A higher-pressure blower may be needed, but this will need to be evaluated.

Combustion Air Inlet Pressure Tap

A pressure tap is provided at the combustion air inlet wind box. If it is found that the pressure at the wind box tap is fluctuating and unstable, the tap may need to be relocated upstream of the wind box, but after the final damper.

Burner Gas Pilot

A raw gas pilot is used to ignite the Vortometric burners. The pilot consists of a tube that provides a stream of gas behind the throat of the burner which is ignited by a spark rod. The pilot position in relation to the throat of the burner is adjustable, and should be positioned as described in the Vortometric Installation Guide.

The ALO which controls gas flow to the pilot should be located as close to the pilot as possible to minimize fluctuation as chamber conditions change.

The design should allow access to the pilot so it can be removed for maintenance and, if necessary, spark rod servicing.

Step 3: Control Methodology Control Methods

Fuel control methods for the Vortometric burners will vary depending on which fuels are used. This manual includes five guideline schematics showing the basic, minimum fuel control systems for the following:

Figure 3.4 – Schematic for Natural Gas, Propane, or Butane

Figure 3.5 – Schematic for Natural Gas and #6 Fuel Oil

Figure 3.6 – Schematic for Natural Gas and #2 Fuel Oil

Figure 3.7 – Schematic for #6 Fuel Oil

Figure 3.8 – Schematic for #2 Fuel Oil

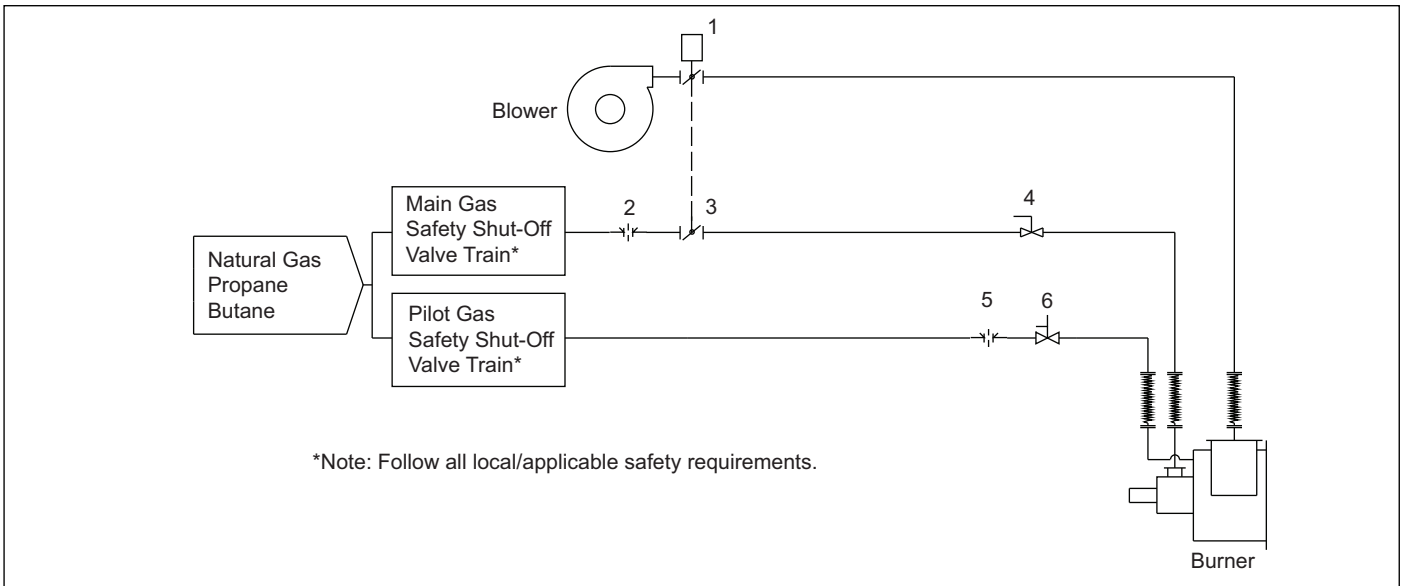

Figure 3.4 - Schematic for Natural Gas, Propane, & Butane

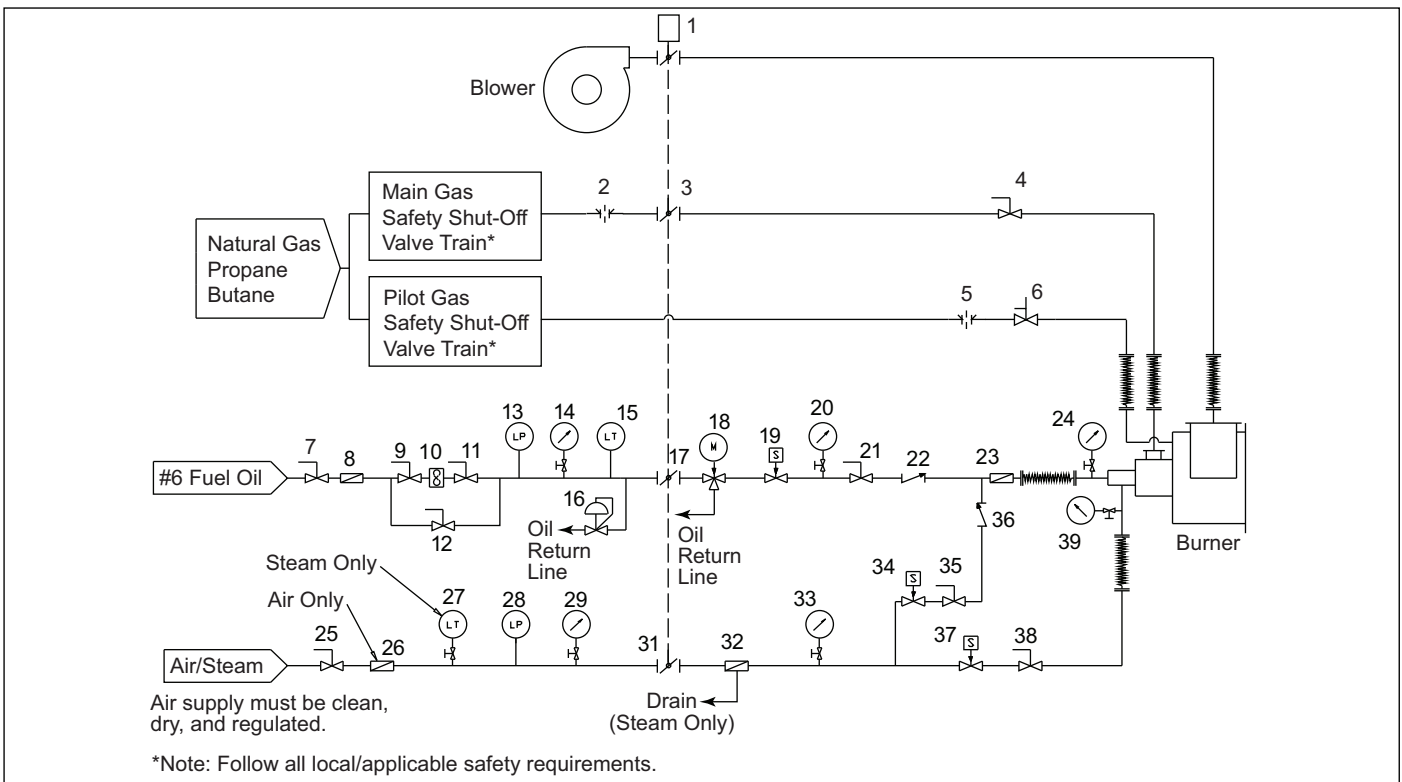

Figure 3.5 - Schematic for Natural Gas, Propane, Butane and #6 Fuel Oil

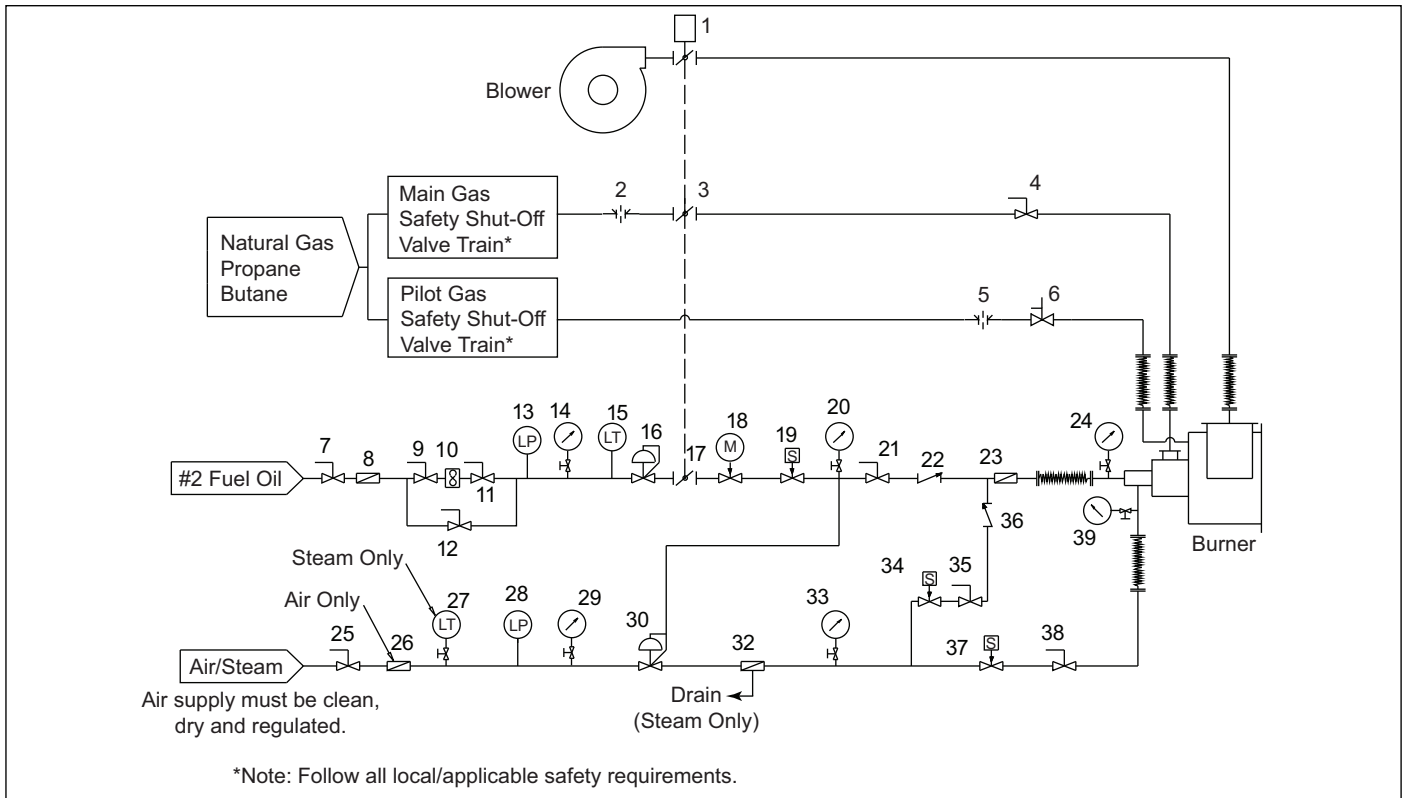

Figure 3.6 - Schematic for Natural Gas, Propane, Butane & #2 Fuel Oil

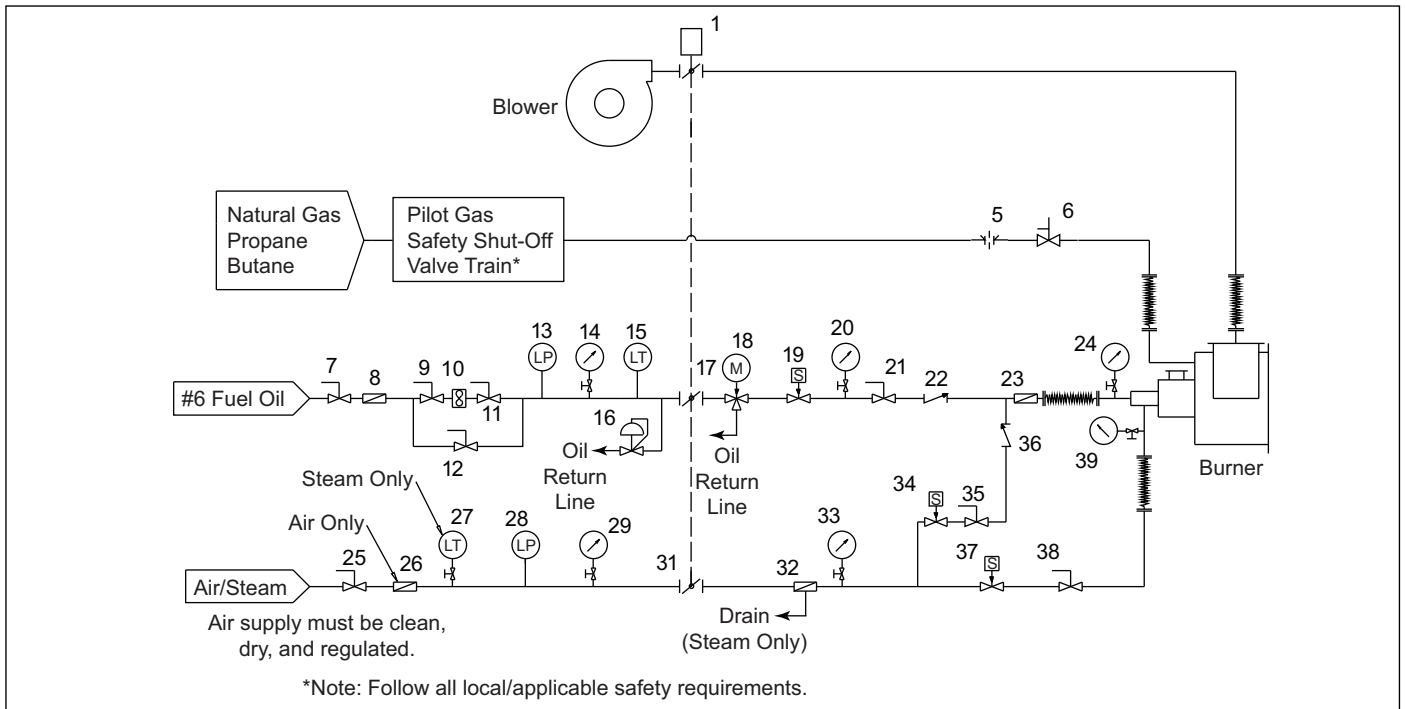

Figure 3.7 - Schematic for #6 Fuel Oil

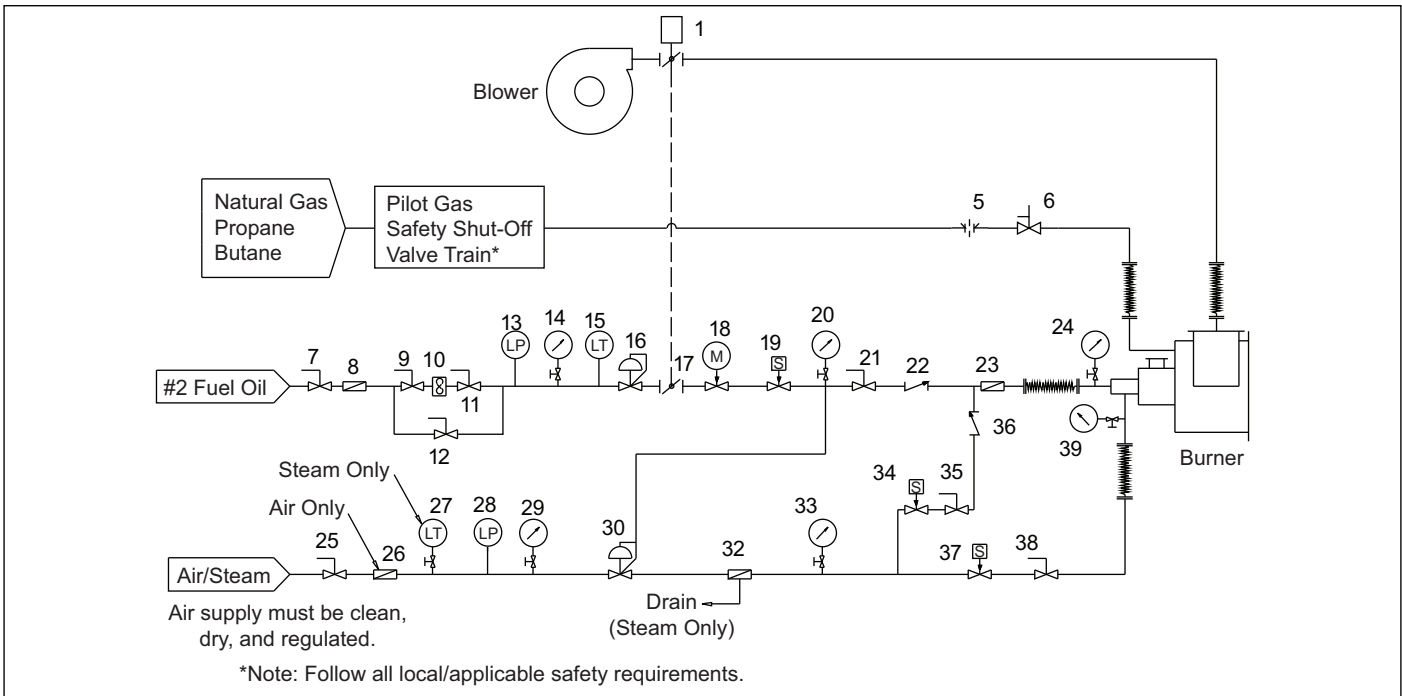

Figure 3.8 - Schematic for #2 Fuel Oil

Table 3.2 - Vortometric Control Circuit Components (See Key to Schematics in the Appendix information)

Item	Description	Item	Description
1	Main Air Control Valve	20	Fuel Oil Pressure Gauge
2	Main Combustion Gas Metering Orifice	21	Fuel Oil Manual Shut-Off Valve
3	Main Combustion Gas Control Valve	22	Fuel Oil Check Valve
4	Main Combustion Gas Shut-Off Valve	23	Fuel Oil Strainer at Lance (40 mesh)
5	Pilot Gas Metering Orifice	24	Fuel Oil Lance Inlet Pressure Gauge
6	Pilot Gas Cock with Adjustable Orifice	25	Atomizing Air/Steam Manual Inlet Shut-Off Valve
7	Fuel Oil Inlet Manual Shut-Off Valve	26	Atomizing Air Strainer (20 mesh)
8	Fuel Oil Strainer at Valve Train Inlet (20 mesh)	27	Atomizing Steam Low Temperature Switch
9	Fuel Oil Manual Shut-Off Valve	28	Atomizing Air/Steam Low Pressure Switch
10	Fuel Oil Flow Meter	29	Atomizing Air/Steam Inlet Pressure Gauge
11	Fuel Oil Manual Shut-Off Valve	30	Atomizing Air/Steam Pressure Regulator
12	Fuel Oil Manual Shut-Off Valve	31	Atomizing Air Flow Control Valve
13	Fuel Oil Low Pressure Switch	32	Condensate Trap (Steam Only)
14	Fuel Oil Inlet Pressure Gauge	33	Atomizing Air/Steam Pressure Gauge
15	Fuel Oil Low Oil Temperature Switch	34	Fuel Oil Purge Line Solenoid Shut-Off Valve
16	Fuel Oil Pressure Regulator	35	Fuel Oil Purge Line Manual Shut-Off Valve
17	Fuel Oil Flow Control Valve	36	Fuel Oil Purge Line Check Valve
18	Fuel Oil Motorized Valve (2 way for #2 oil and 3 way for #6 oil)	37	Atomizing Air/Steam Solenoid Shut-Off Valve
19	Fuel Oil Safety Solenoid Shut-Off Valve	38	Atomizing Air/Steam Manual Shut-Off Valve
		39	Atomizing Air/Steam Inlet Pressure Gauge

Additional Requirements

Fuel Train Safety Systems

The fuel train safety system should be designed to meet the requirements of the local codes and insurance carriers. For more information on fuel train safety recommendations for your application, contact Eclipse.

Fuel Oil Train

Fuel supply and control systems for oil fired burners must include an oil flow meter and adequate strainers for proper setup and operation. A 20 mesh (841 micron) strainer is required at the inlet to the oil trains and a 40 mesh (400 micron) strainer is required at the oil lance.

An air purge is required to the oil lance to clear the line after shutdown when oil is not flowing. The line used to purge the fuel oil lance during shutdown needs to be piped above the fuel line to prevent fuel oil from seeping back into it which would clog the line.

The solenoid valve which controls oil flow should be as close to the oil lance as possible. This will help minimize the amount of residual oil in the lines at shutdown.

When using fuel oils with high viscosity, such as No. 6 fuel oil, heat tracing is needed to keep the oil warm when the flow to the oil lance is stopped, or when ambient temperatures are low enough to cool down the oil. The recommended heat tracing rating is 1.2 to 1.6 watts/cm².

Fuel Oil Supply System

The fuel oil supply system should be sized to provide 150% of the required flow. This will allow adequate recirculation back to the reservoir which will provide tank agitation and consistent oil temperature even at full input. Heating the oil is required when using heavy oil, such as #6 fuel oil, or where increased viscosity due to a cold environment may interfere with oil flow. Maximum recommended oil viscosity at operating temperature is 150 SSU.

Viewing Port

On oil fired burners, a view port or peepsight must be provided to view the flame from the downstream end of the combustion chamber. It is also recommended to provide a view port or peepsight in the chamber for non-oil burning applications.

Step 4: Ignition System

For the Ignition System Use:

- 6,000 VAC transformer
- Full-wave spark transformer

DO NOT USE:

- 10,000 VAC transformer
- Twin outlet transformer
- Distributor type transformer
- Half-wave transformer

Eclipse recommends a low fire start be used.

NOTE: You must follow the control circuits described in the previous section, "Control Methodology", to obtain reliable ignition.

Local safety and insurance require limits on the maximum trial for ignition time. These time limits vary from country to country.

The time it takes for a burner to ignite depends on:

- The gas flow at start conditions
- The distance between the gas shut-off valve and the pilot

It is possible to have the pilot too low to ignite within the trial for ignition period. Under these conditions you must consider the following options:

- Extend the time for ignition (allowable under certain conditions depending on local safety codes)
- Resize and/or relocate the gas controls closer to the gas/oil lance

Step 5: Flame Monitoring System

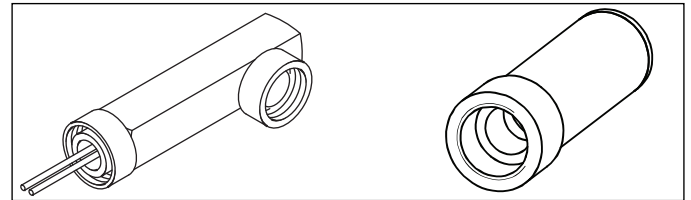

Figure 3.9 - UV Scanner

A flame monitoring system consists of two parts:

- A flame sensor
- A flame monitoring control



- **UV Scanners are NOT interchangeable and must be matched with the flame monitoring control being used.**

Flame Sensor

Vortometric burners can be supplied with UV sensor for flame detection. For typical natural gas applications the UV sensor is recommended. Some UV sensors may not detect reliably when burning fuel oil, high hydrogen fuels such as bio-gas, or under high CO conditions. For heavy oil with steam atomization, two scanners must be used. Because atomizing steam absorbs ultraviolet light, a scanner mounted near the pilot will only prove the pilot flame.

NOTE: Due to the low UV content of oil flames, some UV scanner/flame safety systems may have difficulty sighting oil flames at high inputs. In these cases, a more sensitive UV detector may be required or an infrared (IR) detector may be used. Contact Eclipse for support.

Final selection of flame sensor depends on system design and chamber conditions. Contact Eclipse for questions regarding which type of sensor would be best for a given application.

You can find information in:

- Info Guide 852; (for 90° UV Scanners)
- Info Guide 854; (for Straight UV Scanners)
- Info Guide 856; (for Self-Check UV Scanners)
- You can find more information on UV Scanners in Info Guide 832
- Instruction Manuals 830-1 and 830-2

Flame Monitoring Control

The flame monitoring control processes the signal from the flame sensor and controls the start-up and shut-down sequences.

Eclipse recommends the following flame monitoring controls:

- Trilogy series T400; see Instruction Manual 830
- Veri-Flame series 5600; see Instruction Manual 818

NOTICE

■ **If other controls are considered, contact Eclipse to determine how burner performance may be affected. Flame monitoring controls that have lower sensitivity flame detecting circuits may limit burner turndown and change the requirements for ignition. Flame monitoring controls that stop the spark as soon as a signal is detected may prevent establishment of flame, particularly when using UV scanners. The flame monitoring control must maintain the spark for a fixed time interval that is long enough for ignition.**

Because the Vortometric burner uses a separate pilot and a single sensor, the operational control mode for the flame monitoring system must be "interrupted pilot". See Eclipse Engineering Guide (EFE 825) or contact Eclipse for more information.

Step 6: Combustion Air System: Blower

Effects of Atmospheric Conditions

Blower data is based on the International Standard Atmosphere (ISA) at Mean Sea Level (MSL), which means that it is valid for:

- Sea level
- 29.92" Hg (1013 mbar)
- 70°F (21°C)

The makeup of air is different above sea level or in a hot environment. The density of the air decreases, and as a result, the outlet pressure and the flow of the blower decrease. An accurate description of these effects is in the Eclipse Engineering Guide (EFE 825). The Guide contains tables to calculate the effect of pressure, altitude and temperature on air.

Blower

The rating of the blower must match the system requirements. You can find all the blower data in Bulletin/Info Guide 610.

Follow these steps:

1. Calculate the outlet pressure. When calculating the required outlet pressure of the blower, the total of these pressures must be calculated.
 - The static air pressure required at the burner
 - The total pressure drop in the piping
 - The total of the pressure drops across the valves
 - The pressure in the chamber (suction or pressurized)
 - A minimum safety margin of 10%
2. Calculate the required flow. The blower output is the air flow delivered under standard atmospheric conditions. It must be enough to feed all the burners in the system at high fire.

NOTE: When using the air cooled combustor, approximately 15% additional air flow is required.

Combustion air blowers are normally rated in terms of standard ft³/h or Nm³/h of air.

Fuel Gas	Stoichiometric Air/Gas Ratio α (ft ³ _{air} /ft ³ _{gas})	Gross Heating Value q (BTU/ft ³)
Natural Gas (Birmingham, AL)	9.41	1,002
Propane	23.82	2,572
Butane	30.47	3,225

See Example Blower Calculations below.

Fuel Gas	Stoichiometric Air/Gas Ratio α (ft ³ _{air} /ft ³ _{gas})	Gross Heating Value q (BTU/ft ³)
#2 Oil	1371	140,000

Fuel Gas	Stoichiometric Air/Gas Ratio α (ft ³ _{air} /ft ³ _{gas})	Gross Heating Value q (BTU/ft ³)
#6 Oil	1518	155,000

Example Blower Calculations

Application Example:

“A dryer has been designed and requires a heat input of 10,300,000 BTU/hr. It has been decided to provide the required heat input with one burner operating on natural gas using 15% excess air.”

Calculation Example:

- a. Calculate the gross heat input assuming 60% gross efficiency

$$Q_{\text{gross}} = \frac{Q_{\text{net}}}{\text{Efficiency}} = \frac{10,300,000 \text{ BTU/hr}}{.6} = 17,000,000 \text{ BTU/hr}$$

- b. Use the Vortometric datasheets to decide which burner model is appropriate. In this case, the Vortometric MI 10V with air cooled combustor.

- c. Calculate Required Gas Flow

$$V_{\text{gas}} = \frac{Q_{\text{gross}}}{q} = \frac{17,000,000}{1,002 \text{ BTU/ft}^3} = 16,966 \text{ ft}^3/\text{hr}$$

- Gas flow of 16,966 ft³/hr is required

- d. Calculate required stoichiometric air flow:

$$V_{\text{air-Stoichiometric}} = a(\text{air/gas ratio}) \times V_{\text{gas}} = 9.41 \times 16,966 \text{ ft}^3/\text{hr} = 159,650$$

- Stoichiometric air flow of 159,650 scfh required

- e. Calculate burner air flow requirement based on the desired amount of excess air:

$$V_{\text{air}} = (1 + \text{excess air \%}) \times V_{\text{air-Stoichiometric}} = (1 + 0.15) \times 159,650 \text{ ft}^3/\text{hr} = 183,600 \text{ ft}^3/\text{hr}$$

- For this example, final blower air flow requirement is 183,600 scfh at 15% excess air

- f. Calculate air flow requirement through the air cooled combustor (15% more air is needed when using the air cooled combustor):

$$V_{\text{combustor}} = .15 \times V_{\text{air}} = .15 \times 183,600 \text{ ft}^3/\text{hr} = 27,540 \text{ ft}^3/\text{hr}$$

- g. Calculate final blower air requirement:

$$V_{\text{total}} = V_{\text{combustor}} + V_{\text{air}} = 27,540 \text{ ft}^3/\text{hr} + 183,600 \text{ ft}^3/\text{hr} = 211,140 \text{ ft}^3/\text{hr}$$

- For this example, total air flow requirement is 211,140 scfh for the burner and the air cooled combustor.

- h. Add a 10% safety margin:

$$V_{\text{final}} = V_{\text{total}} \times 1.1 = 211,140 \text{ ft}^3/\text{hr} \times 1.1 = 232,254 \text{ ft}^3/\text{hr}$$

Final flow requirement is 232,254 ft³/hr

This flow is required at the pressure stated in Datasheet 128-3.

Step 7: Main Gas Shut-Off Valve Train

Consult Eclipse

Eclipse can help you design and obtain a main gas shut-off valve train that complies with the current safety standards. The shut-off valve train must comply with all

the local safety standards set by the authorities that have jurisdiction. For details, please contact Eclipse.

NOTE: Eclipse recommends two shut-off valves as a minimum standard for main gas safety shut-off systems as required by North American NFPA and European EN regulations.

Step 8: Process Temp. Control System

Consult Eclipse

The process temperature control system is used to control and monitor the temperature of the system. There is a wide variety of control and measuring equipment available. For details, please contact Eclipse.



Appendix

Conversion Factors

Metric to English

From	To	Multiply By
actual cubic meter/h (am ³ /h)	actual cubic foot/h (acfh)	35.31
normal cubic meter/h (Nm ³ /h)	standard cubic foot /h (scfh)	38.04
degrees Celsius (°C)	degrees Fahrenheit (°F)	(°C x 9/5) + 32
kilogram (kg)	pound (lb)	2.205
kilowatt (kW)	Btu/h	3415
meter (m)	foot (ft)	3.281
millibar (mbar)	inches water column ("w.c.)	0.402
millibar (mbar)	pounds/sq in (psi)	14.5 x 10 ⁻³
millimeter (mm)	inch (in)	3.94 x 10 ⁻²
MJ/Nm ³	Btu/ft ³ (standard)	26.86

Metric to Metric







From	To	Multiply By
kiloPascals (kPa)	millibar (mbar)	10
meter (m)	millimeter (mm)	1000
millibar (mbar)	kiloPascals (kPa)	0.1
millimeter (mm)	meter (m)	0.001



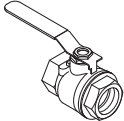
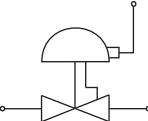
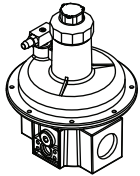
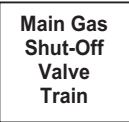

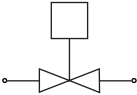
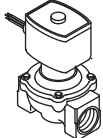



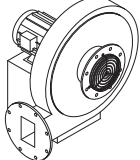

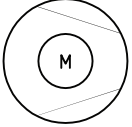
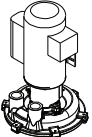
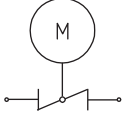
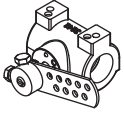
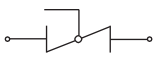
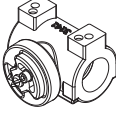
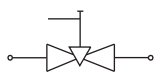

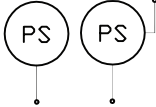

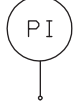
English to Metric

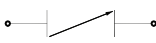
From	To	Multiply By
actual cubic foot/h (acfh)	actual cubic meter/h (am ³ /h)	2.832 x 10 ⁻²
standard cubic foot /h (scfh)	normal cubic meter/h (Nm ³ /h)	2.629 x 10 ⁻²
degrees Fahrenheit (°F)	degrees Celsius (°C)	(°F - 32) x 5/9
pound (lb)	kilogram (kg)	0.454
Btu/h	kilowatt (kW)	0.293 x 10 ⁻³
foot (ft)	meter (m)	0.3048
inches water column ("w.c.)	millibar (mbar)	2.489
pounds/sq in (psi)	millibar (mbar)	68.95
inch (in)	millimeter (mm)	25.4
Btu/ft ³ (standard)	MJ/Nm ³	37.2 x 10 ⁻³

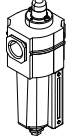

System Schematics

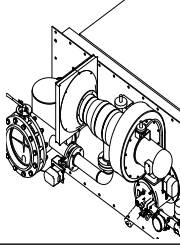
Symbol	Appearance	Name	Remarks	Bulletin/ Info Guide
		Gas Cock	Gas cocks are used to manually shut off the gas supply.	710
		Ratio Regulator	A ratio regulator is used to control the air/gas ratio. The ratio regulator is a sealed unit that adjusts the gas pressure in ratio with the air pressure. To do this, it measures the air pressure with a pressure sensing line, the impulse line. This impulse line is connected between the top of the ratio regulator and the burner body.	742
		Main Gas Shut-Off Valve Train	Eclipse strongly endorses NFPA as a minimum.	790/791
		Pilot Gas Valve Train	Eclipse strongly endorses NFPA as a minimum.	790/791
		Automatic Shut-Off Valve	Shut-off valves are used to automatically shut off the gas supply on a gas system or a burner.	760
		Orifice Meter	Orifice meters are used to measure flow.	930
		Combustion Air Blower	The combustion air blower provides the combustion air to the burner(s).	610

Symbol	Appearance	Name	Remarks	Bulletin/ Info Guide
		Hermetic Booster	Booster is used to increase gas pressure.	620
		Automatic Butterfly Valve	Automatic butterfly valves are typically used to set the output of the system.	720
		Manual Butterfly Valve	Manual butterfly valves are used to balance the air or gas flow at each burner.	720
		Adjustable Limiting Orifice	Adjustable limiting orifices are used for fine adjustment of gas flow.	728/730
		Pressure Switch	A switch activated by rise or fall in pressure. A manual reset version requires pushing a button to transfer the contacts when the pressure set point is satisfied.	840
		Pressure Gauge	A device to indicate pressure.	940
		Check Valve	A check valve permits flow only in one direction and is used to prevent back flow of gas.	780
		Strainer	A strainer traps sediment to prevent blockage of sensitive components downstream.	
		Flexible Connector	Flexible connectors isolate components from vibration, mechanical, and thermal stresses.	
		Heat Exchanger	Heat exchangers transfer heat from one medium to another.	500
		Pressure Taps	Pressure taps measure static pressure.	

